



Microwave Oven
INSTRUCTION MANUAL
Model:EM925RYS

Read these instructions carefully before using your microwave oven, and keep it carefully.

If you follow the instructions, your oven will provide you with many years of good service.

SAVE THESE INSTRUCTIONS CAREFULLY

PRECAUTIONS TO AVOID POSSIBLE EXPOSURE TO EXCESSIVE MICROWAVE ENERGY

- (a) Do not attempt to operate this oven with the door open since this can result in harmful exposure to microwave energy. It is important not to break or tamper with the safety interlocks.
- (b) Do not place any object between the oven front face and the door or allow soil or cleaner residue to accumulate on sealing surfaces.
- (c) **Do not operate the oven if it is damaged. It is particularly important that the oven door closes properly and that there is no damage to the:**
 - (1) **DOOR (bent)**
 - (2) **HINGES AND LATCHES (broken or loosened)**
 - (3) **DOOR SEALS AND SEALING SURFACE**
- (d) **The oven should not be adjusted or repaired by anyone except properly qualified service personnel.**

ADDENDUM

If the apparatus is not maintained in a good state of cleanliness, its surface could be degraded and affect the lifespan of the apparatus and lead to a dangerous situation.

Specifications

Model:	EM925RYS
Rated Voltage:	120V~ 60Hz
Rated Input Power(Microwave):	1350W
Rated Output Power(Microwave):	900W
Oven Capacity:	1.0 Cu.ft.
Turntable Diameter:	Ø 12.4 inch
External Dimensions:	19.1X14.8X11.3 inch
Net Weight:	Approx.29.1 Lbs
Warning:	Handling the cord on this press or cords associated with accessories sold with this product, will expose you to lead a chemical known to the state of California to cause cancer, and birth defects or other reproductive harm. Wash hands after handling.

SAFETY

1. The oven must be on a level surface.
2. The turntable and turntable roller rest must be in the oven during cooking. Place the cookware gently on the turntable and handle it carefully to avoid possible breakage.
3. Incorrect use of browning dish may cause the turntable to break.
4. Use only the specified bag size when using Popcorn.
5. The oven has several built-in safety switches to ensure that the power remains off when the door is open. Do not tamper with these switches.
6. Do not operate the microwave oven empty. Operating the oven with no food or food that is extremely low in moisture can cause fire, charring or sparking.
7. Do not cook bacon directly on the turntable. Excessive heating of the turntable may cause the turntable to break.
8. Do not heat baby bottles or baby food in the microwave oven. Uneven heating may occur and could cause physical injury.
9. Do not heat narrow-necked containers, such as syrup bottles.
10. Do not attempt to deep-fry in your microwave oven.
11. Do not attempt home canning in this microwave oven, as it is impossible to be sure all contents of the jar have reached boiling temperature.
12. Do not use this microwave oven for commercial purposes. This microwave oven is made for household use only.
13. To prevent delayed eruptive boiling of hot liquids and beverages or scalding yourself, stir liquid before placing the container in the oven and again halfway through cooking time. Let stand in the oven for a short time and stir again before removing the container.
14. Use carefully when cooking food in the microwave oven to avoid burning due to excessive cooking.
15. Failure to maintain the oven in a clean condition could lead to deterioration that could adversely affect the life of the appliance and possibly result in a hazardous situation.

Radio Interference

1. Operation of the microwave oven may cause interference to your radio, TV or similar equipment.
2. When there is interference, it may be reduced or eliminated by taking the following measures:
 - 1) Clean door and sealing surface of the oven
 - 2) Reorient the receiving antenna of radio or television.
 - 3) Relocate the microwave oven with respect to the receiver.
 - 4) Move the microwave oven away from the receiver.
 - 5) Plug the microwave oven into a different outlet so that microwave oven and receiver are on different branch circuits.

IMPORTANT SAFETY INSTRUCTIONS

WARNING

To reduce the risk of fire, electric shock, injury to persons or exposure to excessive microwave oven energy when using your appliance, follow basic precautions, including the following:

1. Read all instructions before using the appliance.
2. Read and follow the specific: **"PRECAUTIONS TO AVOID POSSIBLE EXPOSURE TO EXCESSIVE MICROWAVE ENERGY" on page 2.**
3. As with most cooking appliances, close supervision is necessary to reduce the risk of a fire in the oven cavity.

If materials inside the oven ignite:

1. Keep the oven door closed.
2. Turn the oven off, and unplug the appliance.
3. Disconnect the power cord, shut off power at the fuse or circuit breaker panel.
4. Do not overcook food. Carefully attend the appliance when paper, plastic, or other combustible materials are placed inside the oven to facilitate cooking.
5. Do not use the oven cavity for storage purposes. Do not store combustible items such as bread, cookies, paper products, etc. inside the oven.
6. Remove wire twist-ties and metal handles from paper or plastic containers/bags before placing them in the oven.
7. This oven must be grounded. Connect only to properly grounded outlet. See **"GROUNDING INSTRUCTIONS" on page 5.**
8. Install or locate this oven only in accordance with the installation instructions provided.
9. Some products such as whole eggs, water with oil or fat, sealed to explode and therefore should not be heated in this oven.
10. Use this appliance only for its intended uses as described in this manual. Do not use corrosive chemicals or vapors in this appliance. This oven is specifically designed to heat or cook food. It is not designed for industrial or laboratory use.
11. As with any appliance, close supervision is necessary when used by children.
12. Do not operate this oven if it has a damaged cord or plug, if it is not working properly or if it has been damaged or dropped.
13. This appliance should be serviced only by qualified service technicians. Contact the nearest authorized service facility for examination, repair or adjustment.
14. Do not cover or block any vents on the oven.
15. Do not store or use this appliance outdoors.
16. Do not use this oven near water, for example, near a kitchen sink, in a wet basement, near a swimming pool, or similar locations.
17. Do not immerse cord or plug in water.
18. Keep cord away from heated surfaces.
19. Do not let cord hang over edge of table or counter.
20. When cleaning door and oven surfaces use only mild, nonabrasive soaps or detergents applied with a sponge or soft cloth.

21. Liquids, such as water, coffee, or tea are able to be overheated beyond the boiling point without appearing to be boiling. Visible bubbling or boiling when the container is removed from the microwave oven is not always present. THIS COULD RESULT IN VERY HOT LIQUIDS SUDDENLY BOILING OVER WHEN THE CONTAINER IS DISTURBED OR A SPOON OR OTHER UTENSIL IS INSERTED INTO THE LIQUID.

- i) Do not overheat the liquid.
- ii) Stir the liquid both before and halfway through heating it.
- iii) Do not use straight-sided containers with narrow necks.
- iv) After heating, allow the container to stand in the microwave oven for a short time before removing the container.
- v) Use extreme care when inserting a spoon or other utensil into the container.

SAVE THESE INSTRUCTIONS

To Reduce the Risk of Injury to Persons

GROUNDING INSTRUCTIONS

DANGER

Electric Shock Hazard

Touching some of the internal components can cause serious personal injury or death. Do not disassemble this appliance.

WARNING

Electric Shock Hazard

Improper use of the grounding can result in electric shock. Do not plug into an outlet until appliance is properly installed and grounded.

Three-pronged (grounding) plug

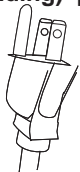

This appliance must be grounded. In the event of an electrical short circuit, grounding reduces the risk of electric shock by providing an escape wire for the electric current. This appliance is equipped with a cord having grounding wire with a grounding plug. The plug must be

plugged into an outlet that is properly installed and grounded.

Consult a qualified electrician or serviceman if the grounding instructions are not completely understood or if doubt exists as to whether the appliance is properly grounded. If it is necessary to use an extension cord, use only a 3-wire extension cord that has a 3-pronged grounding plug, and a 3-slot receptacle that will accept the plug on the appliance. The marked rating of the extension cord shall be equal to or greater than the electrical rating of the appliance.

1. A short power-supply cord is provided to reduce the risks resulting from becoming entangled in or tripping over a longer cord.
2. Longer cord sets or extension cord is provided to reduce the risks resulting from becoming entangled in or tripping over a longer cord.
3. If a long cord sets or extension cord is used:
 - 1) The marked electrical rating of the cord set or extension marked electrical rating of the cord set or extension cord should be at least as great as the electrical rating of the appliance.
 - 2) The extension cord must be a grounding-type 3-wire cord.
 - 3) The longer cord should be arranged so that it will not drape over the countertop or tabletop where it can be pulled on by children or tripped over unintentionally.

UTENSILS

CAUTION

Personal Injury Hazard

Tightly-closed utensils could explode. Closed containers should be opened and plastic pouches should be pierced before cooking.

See the instructions on "Materials you can use in microwave oven or to be avoided in microwave oven." There may be certain non-metallic utensils that are not safe to use for microwaving. If in doubt, you can test the utensil in question following the procedure below.

Utensil Test:

1. Fill a microwave-safe container with 1 cup of cold water (250ml) along with the utensil in question.
2. Cook on maximum power for 1 minute.
3. Carefully feel the utensil. If the empty utensil is warm, do not use it for microwave cooking.
4. **Do not exceed 1 minute cooking time.**

Materials you can use in microwave oven

Utensils Remarks

Aluminum foil	Shielding only. Small smooth pieces can be used to cover thin parts of meat or poultry to prevent overcooking. Arcing can occur if foil is too close to oven walls. The foil should be at least 1 inch (2.5cm) away from oven walls.
Browning dish	Follow manufacturer's instructions. The bottom of browning dish must be at least 3/16 inch (5mm) above the turntable. Incorrect usage may cause the turntable to break.
Dinnerware	Microwave-safe only. Follow manufacturer's instructions. Do not use cracked or chipped dishes.
Glass jars	Always remove lid. Use only to heat food until just warm. Most glass jars are not heat resistant and may break.
Glassware	Heat-resistant oven glassware only. Make sure there is no metallic trim. Do not use cracked or chipped dishes.
Oven cooking bags	Follow manufacturer's instructions. Do not close with metal tie. Make slits to allow steam to escape.
Paper plates and cups	Use for short-term cooking/warming only. Do not leave oven unattended while cooking.
Paper towels	Use to cover food for reheating and absorbing fat. Use with supervision for a short-term cooking only.
Parchment paper	Use as a cover to prevent splattering or a wrap for steaming.
Plastic	Microwave-safe only. Follow the manufacturer's instructions. Should be labeled "Microwave Safe". Some plastic containers soften, as the food inside gets hot. "Boiling bags" and tightly closed plastic bags should be slit, pierced or vented as directed by package.
Plastic wrap	Microwave-safe only. Use to cover food during cooking to retain moisture. Do not allow plastic wrap to touch food.
Thermometers	Microwave-safe only (meat and candy thermometers).
Wax paper	Use as a cover to prevent splattering and retain moisture.

Materials to be avoided in microwave oven

Utensils Remarks

Aluminum tray	May cause arcing. Transfer food into microwave-safe dish.
Food carton with metal handle	May cause arcing. Transfer food into microwave-safe dish.
Metal or metal-trimmed utensils	Metal shields the food from microwave energy. Metal trim may cause arcing.
Metal twist ties	May cause arcing and could cause a fire in the oven.
Paper bags	May cause a fire in the oven.
Plastic foam	Plastic foam may melt or contaminate the liquid inside when exposed to high temperature.
Wood	Wood will dry out when used in the microwave oven and may split or crack.

SETTING UP YOUR OVEN

Names of Oven Parts and Accessories

Remove the oven and all materials from the carton and oven cavity.

Your oven comes with the following accessories:

Glass tray	1
Turntable ring assembly	1
Instruction Manual	1

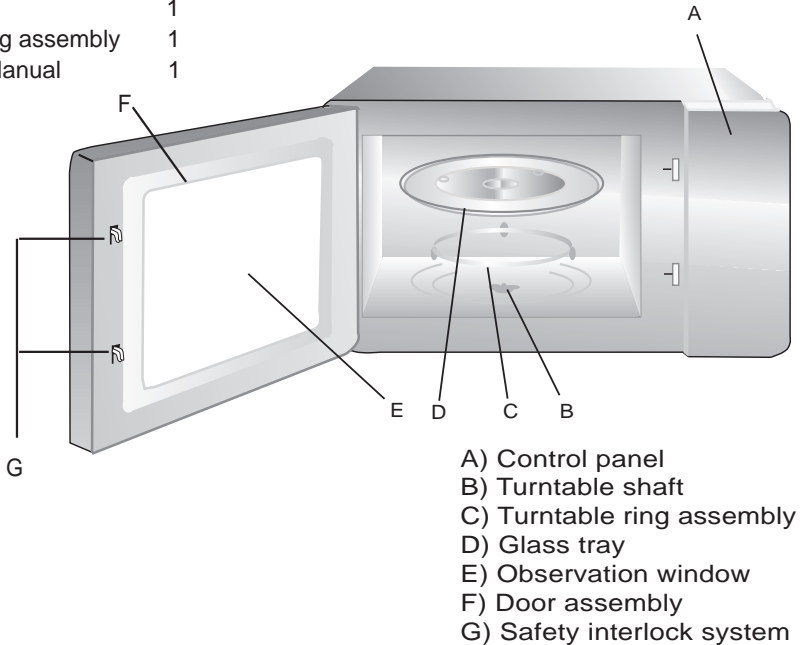

Turntable Installation

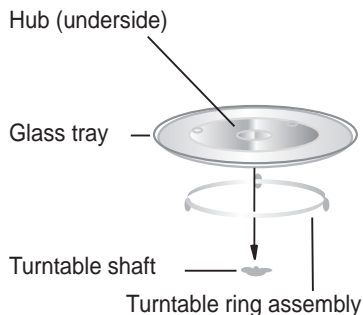

- Never place the glass tray upside down. The glass tray should never be restricted.
- Both glass tray and turntable ring assembly must always be used during cooking.
- All food and containers of food are always placed on the glass tray for cooking.
- If glass tray or turntable ring assembly cracks or breaks, contact your nearest authorized service center.

Countertop Installation

Remove all packing material and accessories. Examine the oven for any damage such as dents or broken door. Do not install if oven is damaged.

Installation

1. Select a level surface that provides enough open space for the intake and/or outlet vents.

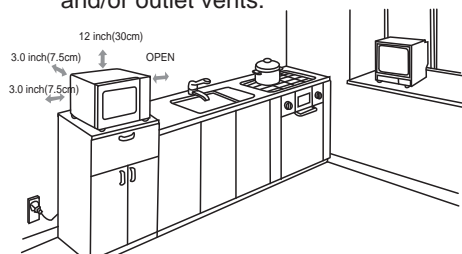

- (1) Leave a minimum clearance of 12 inches (30cm) above the oven.
- (2) Do not remove the legs from the bottom of the oven.

A minimum clearance of 3.0 inches (7.5cm) is required between the oven and any adjacent walls. One side must be open.

For Built-in kits:

a. Model number and brand of built-in kit: KITR2501S, HIGH POINTE

b. MWO model number and brand which employ built-in Kit: EM925RYS, HIGH POINTE

IMPORTANT: This Built-In Kit is ONLY For Use With HIGH POINTE Microwave Ovens Model EM925RYS Where This Built-In Kit, Model KITR2501S Is Specified On .

The Back Of The Unit And In The INSTRUCTION MANUAL.

Cabinet: Remove any protective film found on the microwave oven cabinet surface.

Do not remove the light brown Mica cover that is attached to the oven cavity to protect the magnetron.

- (3) Blocking the intake and/or outlet openings can damage the oven.
- (4) Place the oven as far away from radios and TV as possible. Operation of microwave oven may cause interference to your radio or TV reception.
2. Plug your oven into a standard household outlet. Be sure the voltage and the frequency is the same as the voltage and the frequency on the rating label.

WARNING: Do not install oven over a range cooktop or other heat-producing appliance. Unless using manufactures built-in kit and instructions. If improbably installed near or over a heat source, the oven could be damaged and the warranty would be void.

OPERATION

Control Panel and Features

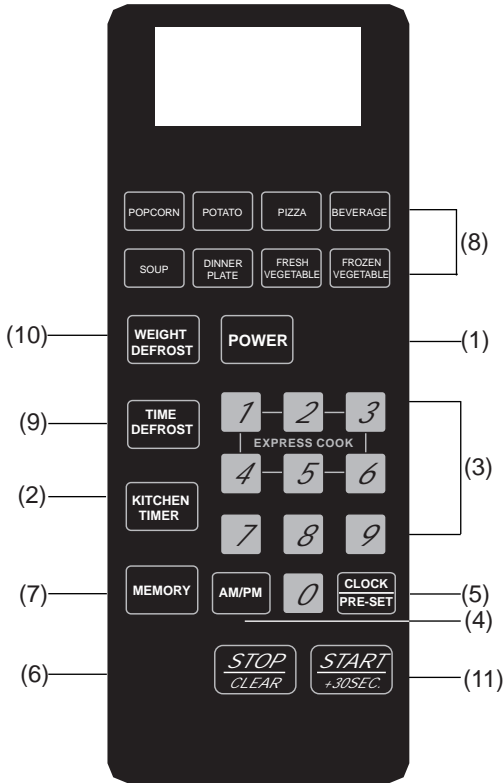

- (1) **Power**
- (2) **Kitchen Timer**
- (3) **Number keys**
- (4) **AM/PM**
- (5) **Clock/Pre-set**
- (6) **Stop/Clear:** clears all previous settings pressed before cooking starts. During cooking: press once to stop oven; twice to stop and clear all entries.
- (7) **Memory**
- (8) **Auto Menu**
- (9) **Time Defrost**
- (10) **Weight Defrost**
- (11) **Start/ +30SEC.**

OPERATION

1. Power Level

Ten power levels are available.

Level	10	9	8	7	6	5	4	3	2	1
Power	100%	90%	80%	70%	60%	50%	40%	30%	20%	10%
Display	PL10	PL9	PL8	PL7	PL6	PL5	PL4	PL3	PL2	PL1

Remarks: when a power between level 10-8 is chosen, the high level indicator is lighted and it will flash when in operation.

When a power between level 7-1 is chosen, the low level indicator is lighted and it will flash when in operation.

2. Clock Setting

When the microwave oven is plugged into a outlet, the oven will display " 0:00 "

- (1) Press "**CLOCK/PRE-SET**", LED will display 00:00, clock indicator will be lighted. The hour figures will flash; ":" and "0" will be lighted.
- (2) Press the number keys and enter the correct time. For example, time is 10:12 now, please press "1,0,1,2" in turn.
- (3) Press "**AM/PM**" to choose AM or PM. AM or PM will be selected in turn by pressing the button of " AM/PM " continuously.
- (4) Press "**CLOCK/PRE-SET**" to finish clock setting, and the clock indicator will go out. ":" will flash and the clock will be lighted.
- (5) If the numbers input are not within the range of 1:00--12:59, the setting will be invalid until valid numbers are input.





Note: In the process of clock setting, if the "**STOP/CLEAR**" button is pressed or if there is no operation within 1 minute, the oven will go back to the former state automatically.



3. Kitchen Timer

- (1) Press "**KITCHEN TIMER**", LED will display 00:00, clock indicator will be lighted. The first "0" will flash; ":" and the other "0" will be lighted.
- (2) Press the number keys and enter the correct time.(the maximum cooking time is 99 minutes and 99 seconds)
- (3) Press "**START/+30SEC.**" to confirm setting, clock indicator will be lighted.
- (4) When the kitchen time arrives, clock indicator will go out. The buzzer will ring 5 times. If the clock be set (12-hour system), LED will display the current time by counting down.

Note: The kitchen time is differ from 12-hour system,Kitchen Timer is a timer. That it is to say it processes the function of alarming clock.

4. Microwave cook

- (1) Keep on pressing "**POWER**" to choose microwave power. " " and " " or " " will be lighted.
- (2) Press number keys to input the cooking time; the maximum cooking time is 99 minutes and 99 seconds.

- (3) Press " **START/+30SEC.** " to start cooking, and the remained cooking time will be displayed. ":", "  ", "  " or "  " indicators will flash.





Note: In the process of cooking, if the " **STOP/CLEAR** " button is pressed or if there is no operation within 1 minute, the oven will go back to the former state automatically.

5. Fast Starting

- (1) In waiting state, instant cooking at 100% power level can be started by selecting a cooking time from 1 to 6 minutes by pressing number pads 1 to 6. Press " **START/+30SEC.** " to increase the cooking time; the maximum cooking time is 99 minutes and 59 seconds.
- (2) In waiting state, instant cooking at 100% power level with 30 seconds' cooking time can be started by pressing " **START/+30SEC..** ". Each press on the same button will increase cooking time by 30 seconds. the maximum cooking time is 99 minutes and 59 seconds.





Note: Each pressing on " **START/+30SEC.** " can increase the cooking by 30 seconds for the microwave and Auto menu cooking. However, the operation will not work under "Auto Defrost" (except " defrost by time") operation.

6. Defrosting By W.T. Function

- (1) Press " **WEIGHT DEFROST** ", LED will display "dEF1"; at the same time "  ", "  " indicators will be lighted.
- (2) Press numerical pads to input weight to be defrosted. "Oz" indicator will be lighted. Input the weight ranged between 4~100 Oz.
- (3) If the weight input is not within 4~100, the input will be invalid. No "beep" will be sound and the microwave will not work until valid numbers are input .
- (4) Press " **START/+30SEC.** " to start defrosting and the remained cooking time will be displayed. ":", "  " and "  " indicators will flash and the "Oz" indicator will go out.







7. Time Defrost Function

- (1) Press " **TIME DEFROST** ", LED will display "dEF2". At the same time, "  ", "  " indicators will be lighted.
- (2) Press number pads to input defrosting time. The effective time range is 00:01~99:99
- (3) If the time input is not within 00:01~99:99, no "beep" will be sound and the microwave will not work until valid numbers are input.
- (4) The default microwave power is power level 3. If you want to change the power level, press " **POWER** " once, and the LED will display "PL 3", then press the number pad of the power level you wanted.
- (5) Press " **START/+30SEC.** " to start defrosting. The cooking time remained will be displayed. ":", "  " and "  " indicators will flash.







8. POPCORN

a) Default mode

- 1) Press "**POPCORN**" repeatedly to select popcorn mode, "", " " and "Oz" are light. "1.75", "3.0", "3.5" will appear in the LED in order.
- 2) Press "**START/+30SEC.**" to start cooking, the buzzer will ring once, "Oz" will go out, "", " " will flash.
- 3) When the cooking is over, the buzzer will ring 5 times, LED will display "0:00". If the clock be set (12-hour system), LED will display the current time.



b) Time Adjustable mode (the max.time can be set is 9 minutes and 59 seconds.)

- 1) Press "**POPCORN**" to select popcorn mode, "", " " and "Oz" are light. "1.75", "3.0", "3.5" appear in the LED.
- 2) Press "**MEMORY**", LED will display the cooking time of the selected weight, the minute figure is flashing.
- 3) Press the number keys and enter the time.
- 4) Press "**MEMORY**" to save the setting. If press "**START/+30SEC.**" directly, the oven will start cooking according to the modified time. "", " " will flash. Users can change the cooking time

e.g.: Users set "**POPCORN**" time for 3 minutes and 15 seconds

- 1) Press "**POPCORN**" button once or twice when the oven is on call (the screen will display "1.75" for once press and "3.0" for twice), then press "**MEMORY**" button, LED screen will display the default cooking time of current food deal (which is not 0:00), for example 1'30". on the screen the first number 1 flash, press number button to input 3; the second number 3 flash, press number button to input 1; the third number 0 flash, press number button to input 5. and then the first number 3 flash again (It is similar to clock setting).
- 2) Press "**MEMORY**" again to save current setting. If press "**START/+30SEC.**" to begin cooking directly, the program will save the latest setting of cooking time automatically.
- 3) To change the set cooking time, repeat step 1), the screen will firstly display the saving time (3:15 for example), press number button to reset cooking time, and the follow step 2).
- 4) When completed, whenever press "**POPCORN**" button, LED displays food weight 1.75, 3.0 or 3.5, only cooking time follows the saved time setting.
- 5) To go back to initialization, press "**POPCORN**" button for three seconds, the buzzer will sound, then go back to initial setting.

9. POTATO

a) Press "**POTATO**" repeatedly until the number you needed appears in the LED, "", " " will light.

"1"SET : 1 potato (approximate 230 grams)

"2"SETS: 2 potatoes (approximate 460 grams)

"3"SETS: 3 potatoes (approximate 690 grams)

For example, press "**POTATO**" once : "1" appears in the display.

b) Press "**START/+30SEC.**" to cook, "", " " are flashing.

Times(Press "Potato")	Weight	Display
Once	1set	
Twice	2set	
Thrice	3set	

10. PIZZA

- a) Press " **PIZZA** " repeatedly until the number you wish appears in the LED, " ", " " will light.

You can reheat 1~3 slices of Pizza each time .

Times(Press "Pizza")	Weight	Display
Once	1(3.0 Oz)	
Twice	2(6.0 Oz)	
Thrice	3(9.0 Oz)	

For example, press " **PIZZA** " twice, "2" appears in the LED.

- b) Press " **START/+30SEC.** " to cook, " ", " " are flashing.

11.BEVERAGE

- a) Press " **BEVERAGE** " repeatedly until the number you wish appears in the LED.

" ", " ", " " will light.

You can reheat 1~3 cups of beverage each time (approximate 250 ML).

For example, press " **BEVERAGE** " twice, "2" appears in the LED.

- b) Press " **START/+30SEC.** " to cook,

" "and " " are flashing. " " will go off.

Times(Press "BEVERAGE")	Weight	Display
Once	1 M u g	
Twice	2Mugs	
Thrice	3Mugs	

12.SOUP

- a) Press " **SOUP** " repeatedly until the number you wish appears in the LED.





" ", " " "Oz" will light.



For example, press " **SOUP** " twice, "8.0" appears in the LED.

- b) Press " **START/+30SEC.** " to cook, " ", " " are flashing. "Oz" will go off.





Times(Press "SOUP ")	Weight	Display
Once	4 Oz	
Twice	8 Oz	
Thrice	12 Oz	
4 times	16 Oz	



13. DINNER PLATE

- a) Press " **DINNER PLATE** " repeatedly until the number you need appears in the LED, "  ", "  " and "Oz" **will** light.
For example, press " **DINNER PLATE** " twice, "12.0" appears in the LED.
- b) Press " **START/+30SEC.** " to cook, "  ", "  " are flashing. "Oz" will go off.





Times(Press "DINNER PLATE")	Weight	Display
Once	9.0 Oz	
Twice	12.0 Oz	
Thrice	18.0 Oz	



14.FRESH VEGETABLE

- a) Press " **FRESH VEGETABLE** " repeatedly until the number you needed appears in the display, "  ", "  " and "Oz" light.
For example, press " **FRESH VEGETABLE** " twice, "8.0" appears in LED.
- b) Press " **START/+30SEC.** " to cook, "Oz" disappears, "  ", "  " are flashing."Oz" will go off.

Times(Press "FRESH VEGETABLE")	Weight	Display
Once	4.0 Oz	
Twice	8.0 Oz	
Thrice	16.0 Oz	

15.FROZEN VEGETABLE

- a) Press " **FROZEN VEGETABLE** " repeatedly until the number you wish appears in the display, "  ", "  " and "Oz" light.
For example, press " **FROZEN VEGETABLE** " twice, "8.0" appears in the LED.
- b) Press " **START/+30SEC.** " to cook, "Oz" disappears, "  ", "  " are flashing.

Times(Press "FROZEN VEGETABLE")	Weight	Display
Once	4 Oz	
Twice	8 Oz	
Thrice	16 Oz	

16. PRE-SET FUNCTION

- (1) Set the clock first. (Consult the instruction of clock setting.)
- (2) Set a certain cooking procedure(one or two blocks), the setting method and display are same as relevant cooking procedure. (Defrosting is beyond pre-set cooking).

Example: If you want to cook the food with 100% microwave power for 10 minutes.

Do it as following:

- a. Press "**POWER**" once to choose 100% microwave power;
- b. Press number keys "1","0","0","0" in order to adjust the cooking time;
- c. Be careful! Please do not press "**START/ +30 SEC.**" to start cooking.
- (3) Press "**CLOCK/PRE-SET**" to display current time and hour figure is flashing, the icon " : " keep lighting on.
- (4) Press number keys to input the cooking time.For example: to set the time is 12:12, you can press the number keys "1","2","1","2" in order.
- (5) Press "**AM/PM**" to choose AM or PM. AM or PM will be selected in turn by pressing the button of "**AM/PM**" continuously.
- (6) Press "**START/ +30 SEC.**" to confirm the preset procedure.When it is confirmed, the unit will go back the clock states.
- (7) When time arrives, the buzzer will sound twice and the cooking starts.

17. MEMORY FUNCTION

- (1)Press "**MEMORY**" to choose memory 1-5 procedure. The LED will display 1,2,3...5.
- (2)If the procedure has been set, press "**START/ +30 SEC.**" to use it. If not, continue to set the procedure. Only one or two stages can be set.
- (3) After finishing the setting, press "**MEMORY**" to save the procedure and turn back to the waiting states.If press "**START/ +30 SEC.**" ,it can save and operate the setting.

Example: to set the following procedure as the second memory, that is memory 2.

to cook the food with 80% microwave power for 3minutes and 20 seconds.

The steps are as follow:

- a. In waiting states, press "**MEMORY**" twice,stop pressing until the screen displays "2".
- b. Press "**POWER**" three times until "PL8" displays.
- c. Press number keys "3","2","0" in order to input the cooking time.
- d. Press "**MEMORY**" to save the setting. Buzzer sounds once then turn back to waiting states. If you press "**START/+30SEC.**" after the above step, the procedure will be saved as the memory 2 and operated.
- e. If the electricity is not cut off, the procedure will be saved all the time. If it is, the procedure need to reset.
- f. If you want to run the saved procedure, in waiting states, press "MEMORY" twice, screen displays "2", then press "**START/+30SEC.**" to run.

18. Multi-section cooking

At most 2 sections can be set for cooking. In multi-section cooking, if one section is defrosting, then defrosting shall be placed in the first section. When the first stage finish, the buzzer will sound once and the next stage will begin cooking.

Example: if you want to cook with 80% microwave power for 5 minutes + 60% microwave power for 10 minutes. The cooking steps are as following:

- (1) Press "**POWER**" for times to choose 80% microwave, now "PL8" is displayed;
- (2) Press number keys "5", "0", "0" to set the cooking time;
- (3) Press "**POWER**" for times to choose 60% microwave power, "PL6" is displayed;
- (4) Press number keys "1", "0", "0", "0" to set the cooking time;
- (5) Press "**START/+30SEC.**" to start cooking.

19. INQUIRING FUNCTION

- (1) In cooking state, press " **CLOCK/PRE-SET** ", the LED will display clock for three seconds.
- (2) In the microwave cooking state, press " **POWER** " to inquire microwave power level, and the current microwave power will be displayed. After three seconds, the oven will turn back to the previous state. In multi-stage state, the inquiring way can be done by the same way as above.

20. LOCK FUNCTION FOR CHILDREN

Lock: In waiting state, press " **STOP/CLEAR** " for 3 seconds, there will be a long "beep"

denoting the entering into the children-lock state; meanwhile, LED will display "  "

Lock quitting: In locked state, press " **STOP/CLEAR** " for 3 seconds, there will be a long "beep" denoting that lock is released.

21. COOKING END REMINDING FUNCTION

When the cooking is over, the buzzer will sound 5 "beep" to alert user the cooking is finished.

21. OTHER SPECIFICATIONS

- (1) In standby state , if the set clock digital tube displays current time, the icon " : " would flash; otherwise, it shows " **0:00** ".
- (2) In setting function state, LED displays corresponding setting.
- (3) In working or pause state, LED displays surplus cooking time.

Maintenance

Troubleshooting

Check your problem by using the chart below and try the solutions for each problem. If the microwave oven still does not work properly, contact the nearest authorized service center.

TROUBLE	POSSIBLE CAUSE	POSSIBLE REMEDY
Oven will not start	<ul style="list-style-type: none">a. Electrical cord for oven is not plugged in.b. Door is open.c. Wrong operation is set.	<ul style="list-style-type: none">a. Plug into the outlet.b. Close the door and try again.c. Check instructions.
Arcing or sparking	<ul style="list-style-type: none">a. Materials to be avoided in microwave oven were used.b. The oven is operated when empty.c. Spilled food remains in the cavity.	<ul style="list-style-type: none">a. Use microwave-safe cookware only.b. Do not operate with oven empty.c. Clean cavity with wet towel.
Unevenly cooked foods	<ul style="list-style-type: none">a. Materials to be avoided in microwave oven were used.b. Food is not defrosted completely.c. Cooking time, power level is not suitable.d. Food is not turned or stirred.	<ul style="list-style-type: none">a. Use microwave-safe cookware only.b. Completely defrost food.c. Use correct cooking time, power level.d. Turn or stir food.
Overcooked foods	Cooking time, power level is not suitable.	Use correct cooking time, power level.
Undercooked foods	<ul style="list-style-type: none">a. Materials to be avoided in microwave oven were used.b. Food is not defrosted completely.c. Oven ventilation ports are restricted.d. Cooking time, power level is not suitable.	<ul style="list-style-type: none">a. Use microwave-safe cookware only.b. Completely defrost food.c. Check to see that oven ventilation ports are not restricted.d. Use correct cooking time, power level.
Improper defrosting	<ul style="list-style-type: none">a. Materials to be avoided in microwave oven were used.b. Cooking time, power level is not suitable.c. Food is not turned or stirred.	<ul style="list-style-type: none">a. Use microwave-safe cookware only.b. Use correct cooking time, power level.c. Turn or stir food.

PN:261800309544